

Outline 28 CD
Linear S

C281006

CD Outline S



M281006

Outline 28



Warranty
5 Year Warranty

Control
Standard DMX512 control protocol (Max 44 frames / second).
The communication between fittings can be synchronised perfectly under use of Titan Artnet Controller.

Protection
Lightning and ESD Protection
Electrical Protections: short circuit, over current, over voltage and over temperature.

Ordering Information

Product	Diffuser	Width	Length	LED QTY	LED Color
L	M	28	100	60	03
DMX Linear Bar	C Clear Diffuser M Acrylic Square Diffuser	28mm Wide	030 305mm 060 610mm 090 915mm 120 1220mm 050 500mm 100 1000mm	18 LEDs 36 LEDs 54 LEDs 72 LEDs 30 LEDs 60 LEDs	01 White 03 RGB 04 RGBW

Colors

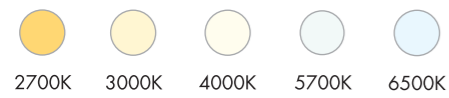

LED

LED Source	SMD3535
LED QTY	60pcs
Beam Angle	120°

Electrical

Input voltage	24VDC/48VDC
power consumption	12W per meter

Control

Protocol	ON/OFF DMX512
Pixels	1 pixel per meter 5 pixel per meter 10 pixel per meter 20 pixel per meter
Addressing options	Auto/Manual addressing

Physical

Housing Material	Aluminium	Mounting Options	Surface mount
Finish	Black/White/Silver	Luminaire Connection	4PIN cable with screw lock connector for DC and DMX
Lenze	Clear		

Environment

Operating Temperature	-30° to 60°	Humidity	0-95%, non-condensing
Startup Temperature	-30° to 60°	IP	Outdoor IP66
Storage Temperature	-40° to 80°		

Certificate

iotaLAMP



Dimension

C281006

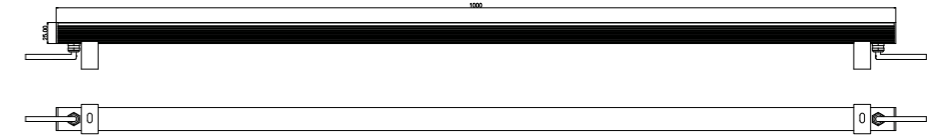
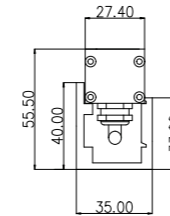

M281006

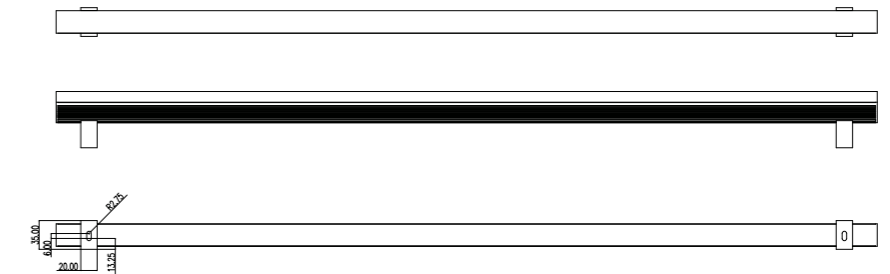
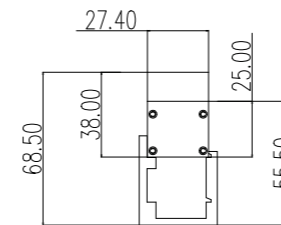

Wiring Diagram

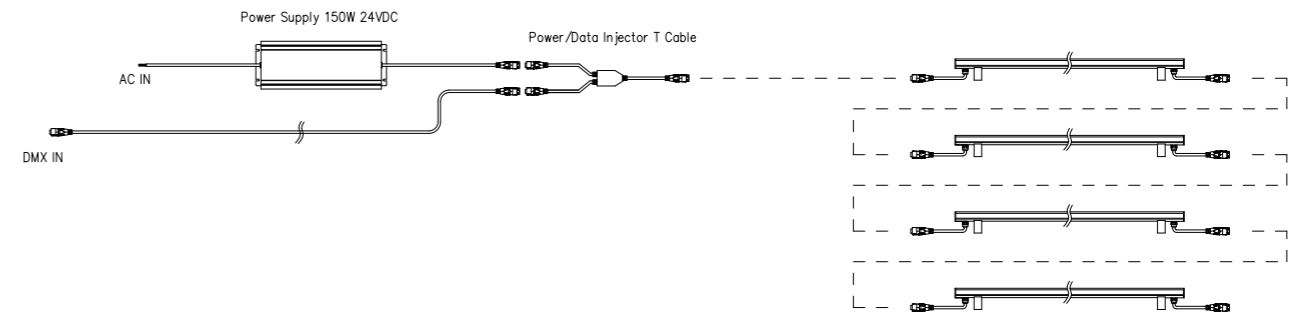

Luminaire Interconnection

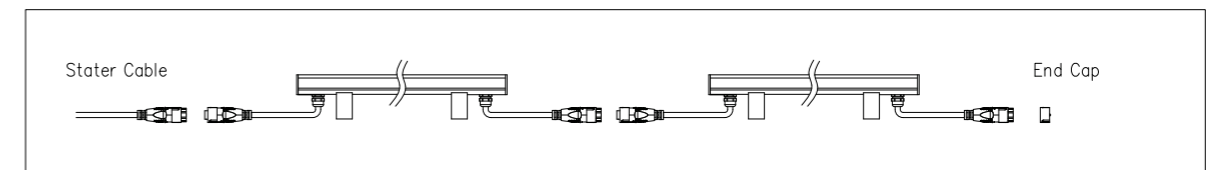

Maximim Run Lengths

	8W per meter	10W per meter	12W per meter	14W per meter
24VDC	up to 18meter	up to 14meter	up to 12meter	up to 10meter
48VDC	up to 36meter	up to 28meter	up to 24meter	up to 20meter